

Notes:

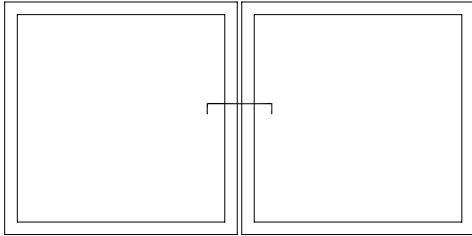

ALTERNATIVE COST OPTION
COUPLING ARRANGEMENT
FOR V200 WINDOWS
WITH TIMBER FILLET

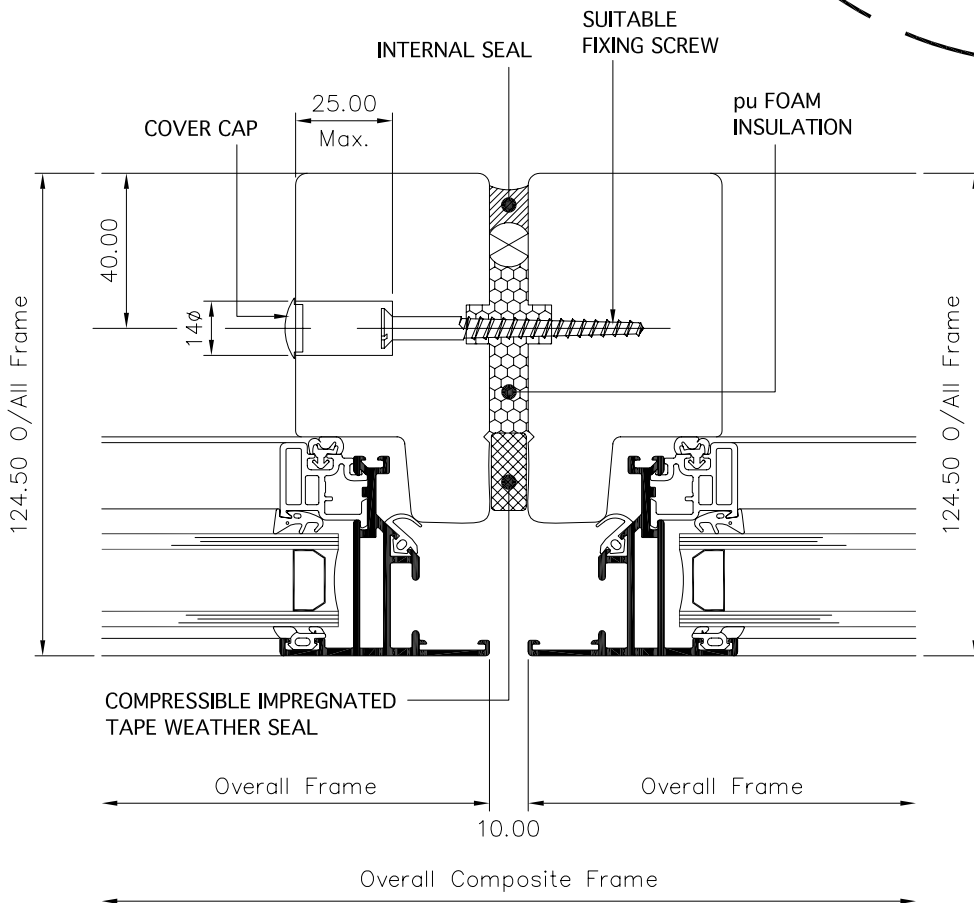
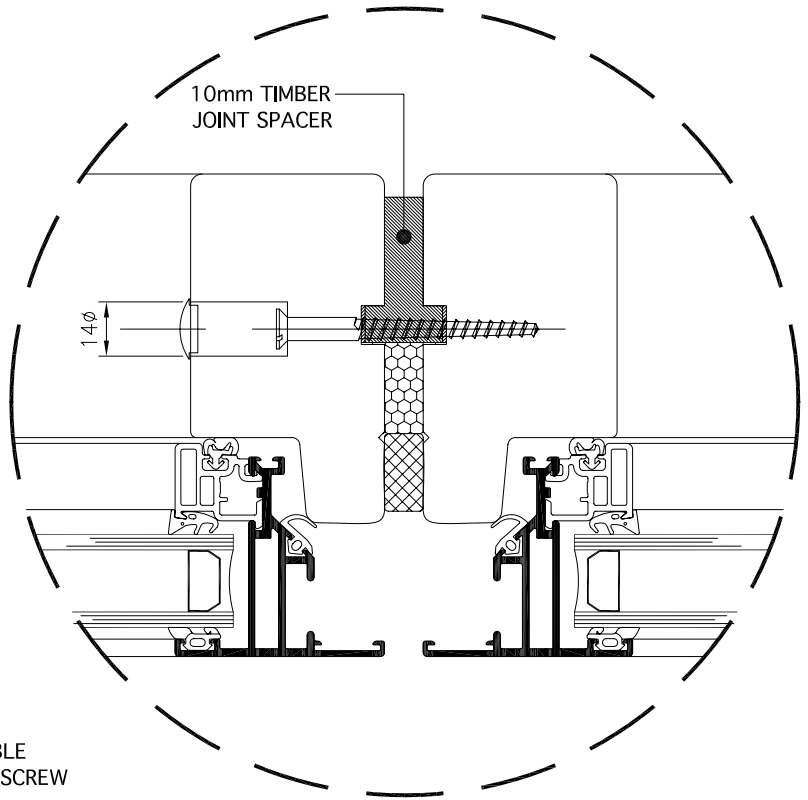

VELFAC Ltd
Tel. +44 1223 897100
Fax. +44 1223 897101
Web. www.VELFAC.co.uk

Title

Typical Vertical Frame Coupling Interface
200 System To 200 System

7					
6					
5					
4					
3					
2	40/10	iDS	Introduction of Alternative Coupling		
1	05/10	iDS	1st Issue		
Rev.	Week/Year	Sign.	Description		

Scale.	1:2/A4
Date.	Feb 10
Drawn By.	iDS
Checked By.	J.R.
Project No.	-
Dwg No.	Coupling.001
Edition No.	2

This drawing must not be used or copied without the permission of VELFAC LTD

Notes:

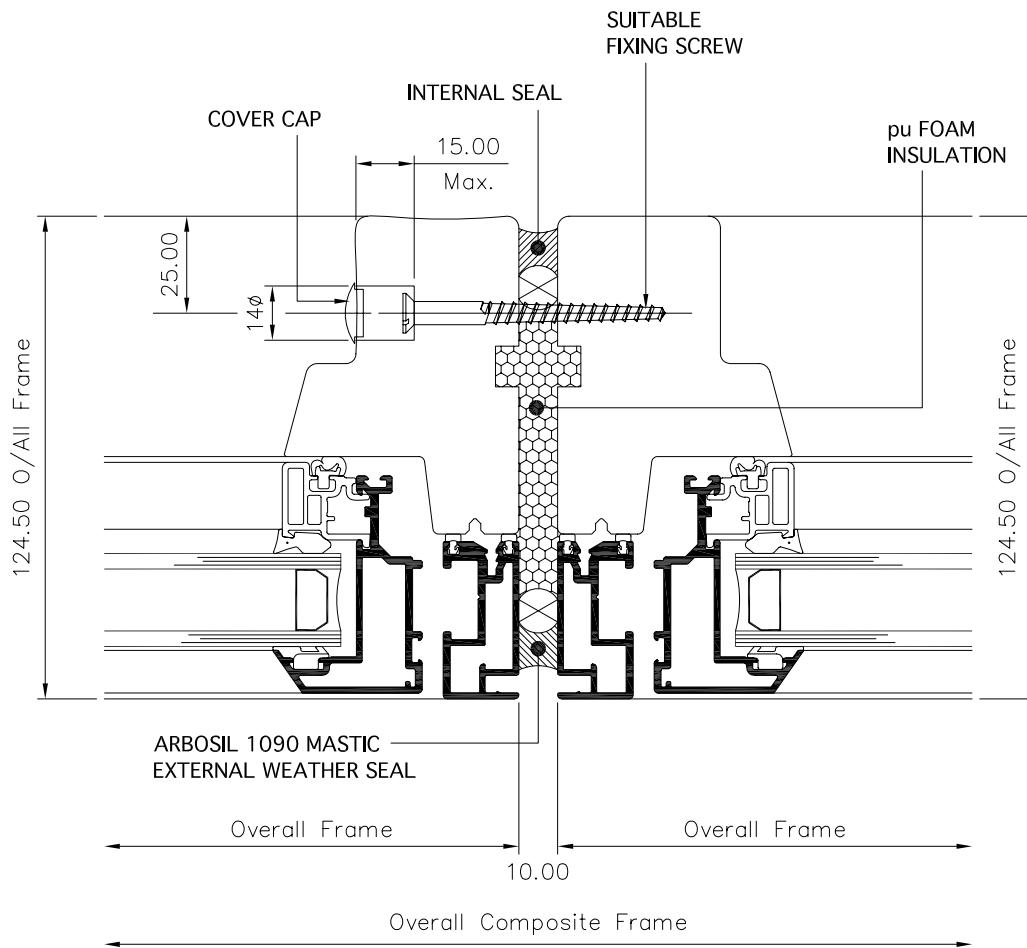
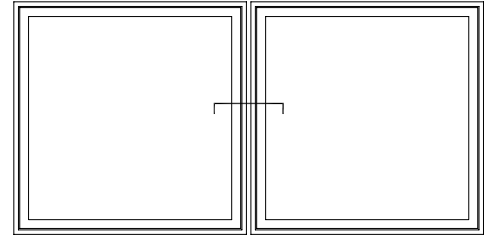

VELFAC Ltd
 Tel. +44 1223 897100
 Fax. +44 1223 897101
 Web. www.VELFAC.co.uk

Title

Typical Vertical Frame Coupling Interface
 400 System To 400 System

7				Scale.	1:2/A4
6				Date.	Feb 10
5				Drawn By.	iDS
4				Checked By.	J.R.
3				Project No.	-
2				Dwg No.	Coupling.002
1	05/10	iDS	1st Issue		
Rev.	Week/Year	Sign.	Description	Edition No.	1

This drawing must not be used or copied without the permission of VELFAC LTD

Notes:

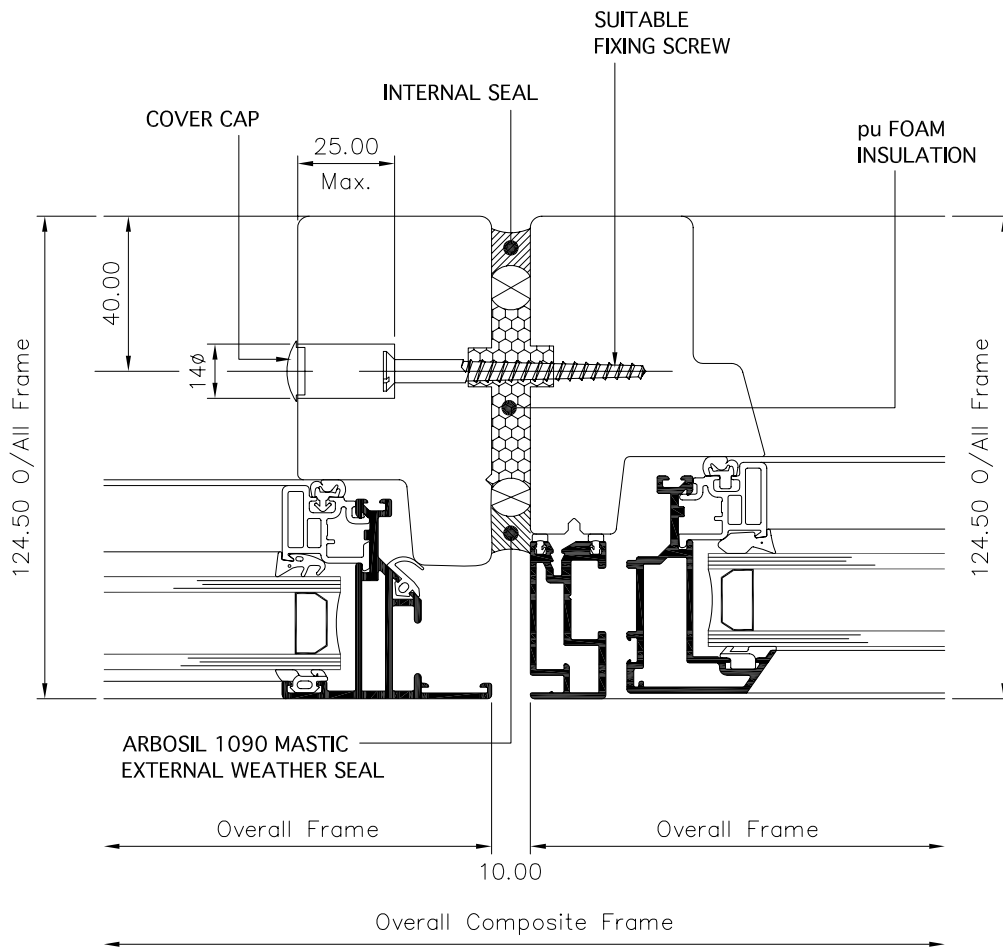
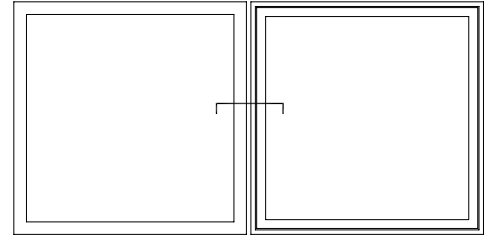

VELFAC Ltd
Tel. +44 1223 897100
Fax. +44 1223 897101
Web. www.VELFAC.co.uk

Title

Typical Vertical Frame Coupling Interface
200 System To 400 System

7				Scale.	1:2/A4
6				Date.	Feb 10
5				Drawn By.	iDS
4				Checked By.	J.R.
3				Project No.	-
2				Dwg No.	Coupling.003
1	05/10	iDS	1st Issue		
Rev.	Week/Year	Sign.	Description	Edition No.	1

This drawing must not be used or copied without the permission of VELFAC LTD